

Duplex Anaesthetic Gas Scavenging Control Panel

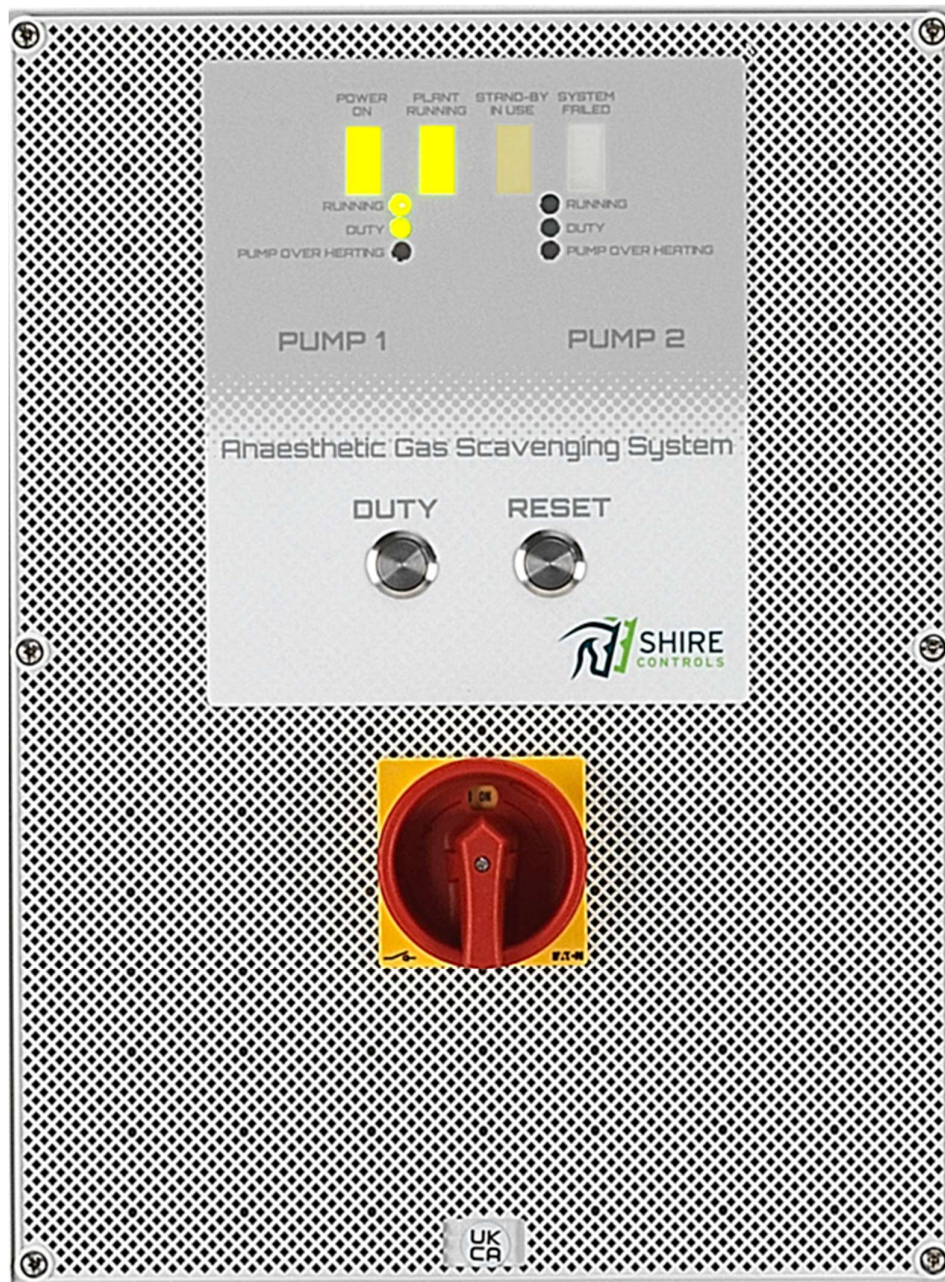
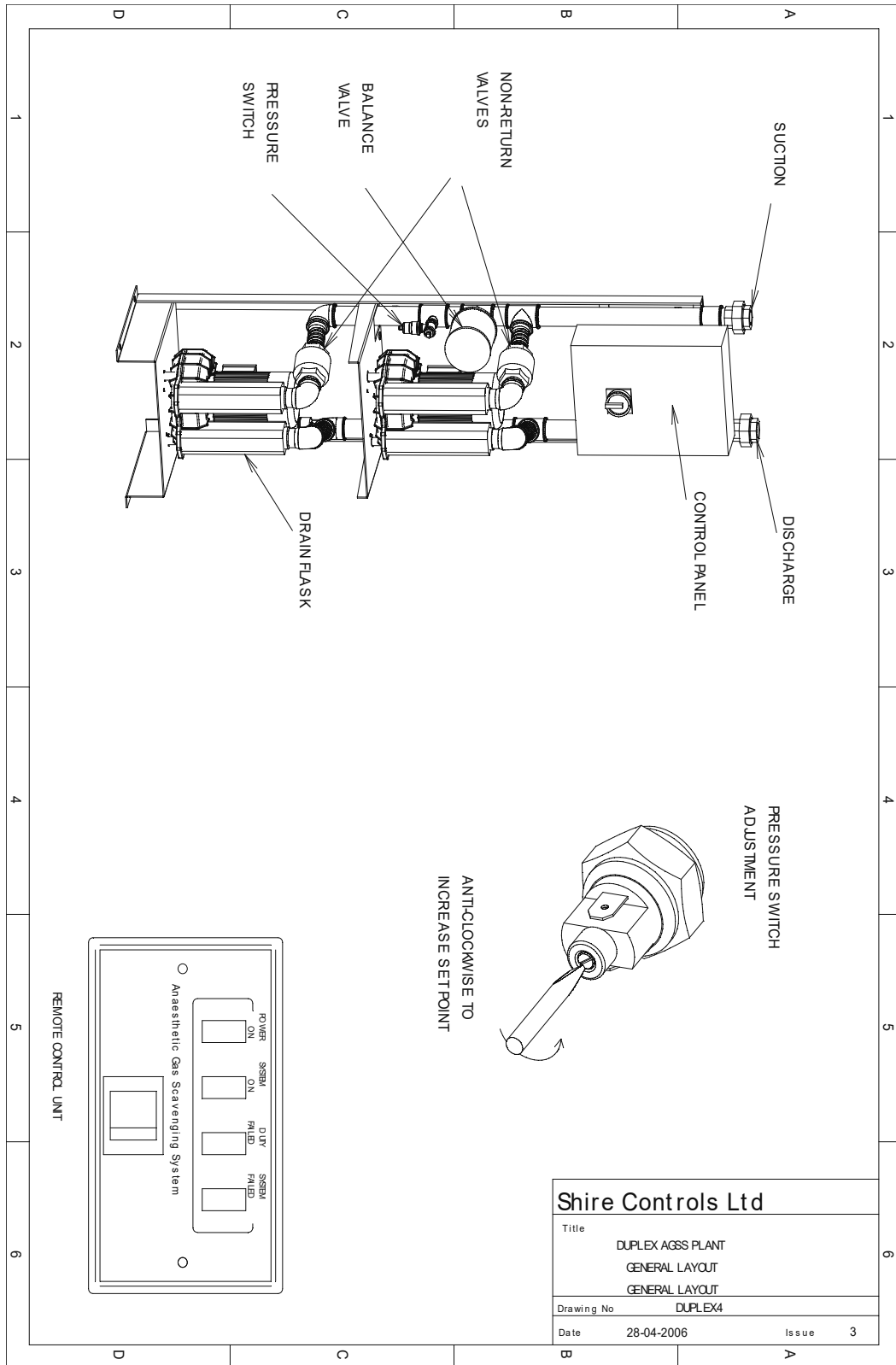



Table of Contents

About this manual	5
Environment	5
Structural	5
Mounting.....	6
Electrical Connections	7
Mechanical	9
Setting Up.....	9
Operator	10
PCB Switch Functions	18
Testing (Switch 2).....	20
Maintenance	21
Symbols.....	22
UDI-DI & UDI-DI Label.....	23
Spares Parts List.....	24
Control Panel Variations	25



Shire Controls Ltd

Title	DUPLX AGSS PLANT GENERAL LAYOUT GENERAL LAYOUT	
Drawing No	DUPLX4	
Date	28-04-2006	Issue 3

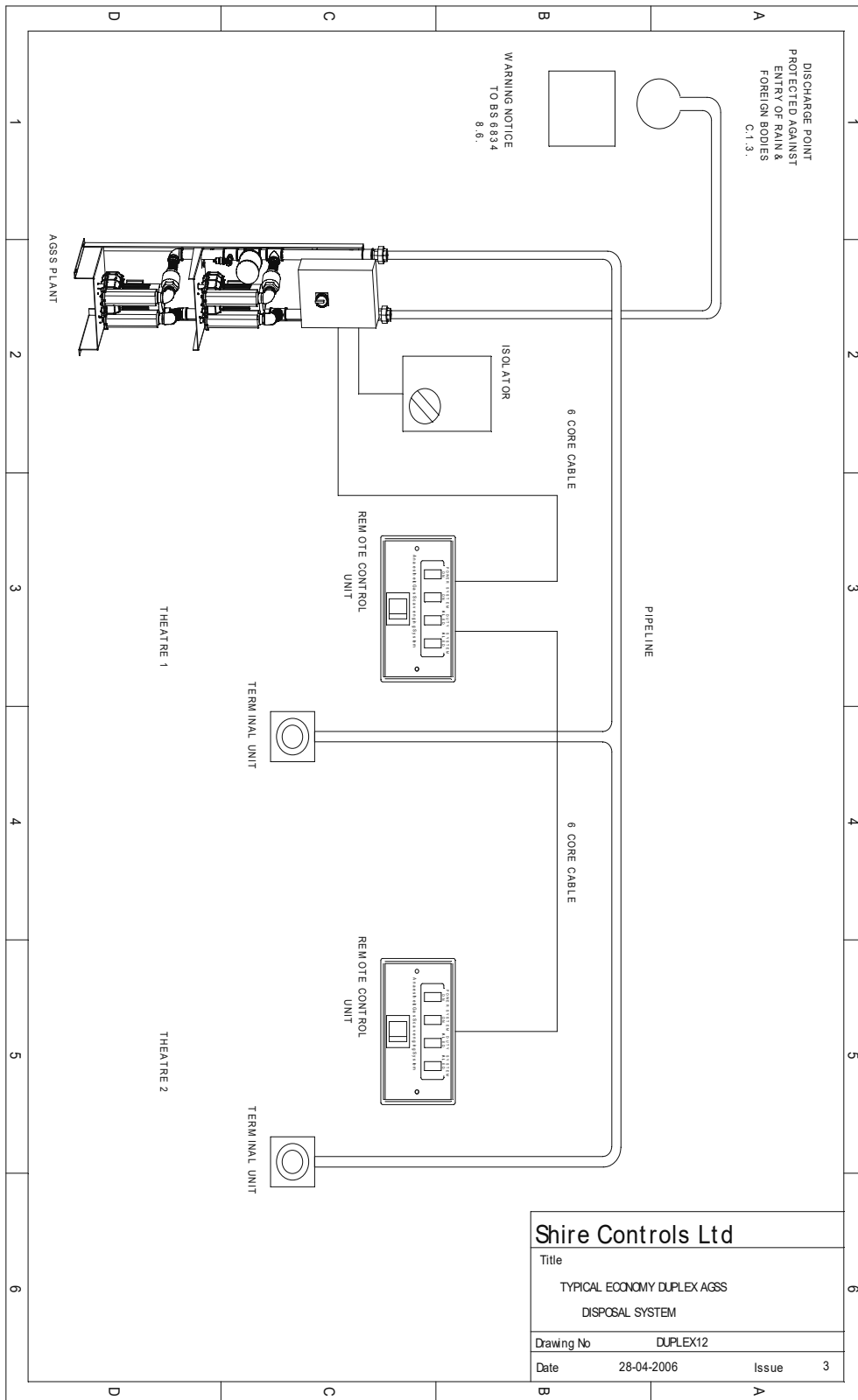

Shire Controls Ltd

Title

TYPICAL ECONOMY DUPLEX AGSS
DISPOSAL SYSTEM

Drawing No DUPLEX12

Date 28-04-2006

Issue 3

About this manual



When you see this symbol, the associated text in bold type refers to something which may cause danger or damage.

Environment

UKCA & EU MDR 2017/745 Compliant

This device is intended for use in a dry, indoor environment such as a hospital plant room, where abnormal levels of airborne dust or condensation are not expected. It is designed to operate safely and effectively under the following environmental conditions:

- **Operating Temperature:** +5°C to +40°C
- **Storage Temperature:** -10°C to +50°C
- **Operating Humidity:** 10% to 85% RH (non-condensing)
- **Storage Humidity:** 10% to 85% RH (non-condensing)
- **Maximum Altitude:** 1000 metres above sea level

These environmental limits are defined to maintain performance, ensure user safety, and protect critical components such as blower pumps and capacitors from degradation. The device contains no internal batteries and is suitable for installation in climate-controlled technical areas. This statement aligns with EU MDR General Safety and Performance Requirements (Annex I, Chapters II & III).

Structural

Enclosure Type:

- The GEWISS GW 42010 is a surface-mounted thermoplastic enclosure, typically IP55-rated, providing protection against dust and water jets.
- Constructed from impact-resistant techno-polymer suitable for indoor use in hospital plant rooms or technical areas.
- Approximate dimensions: 300 x 220 x 160 mm.

Mounting Surface Requirements:

- The enclosure must be securely fixed to a rigid, vertical, non-combustible surface such as a structural wall or mounting backboard.
- The mounting surface must support a minimum static load of 25 kg to accommodate the enclosure, internal components, and service activity.

- Avoid mounting on surfaces that may flex, vibrate, or degrade over time due to environmental exposure.

Fixing and Installation:

- Use all designated mounting points and appropriate fasteners for a secure and vibration-resistant installation.
- To preserve the enclosure's IP rating, use compatible IP-rated cable glands and avoid unsealed entries or modifications.
- Ensure that internal wiring does not obstruct the lid closure or compromise environmental sealing.

Clearance and Accessibility:

- Maintain at least 100 mm clearance on all sides of the enclosure for cable entry, tool access, and heat dissipation.
- Mount the enclosure at a height of 0.6 to 1.9 metres from finished floor level for safe and ergonomic access to indicators, controls, and labels.

Identification and Safety:

- Ensure all labels, UDI identifiers, and status indicators are clearly visible and unobstructed after installation.
- If installed in areas with potential for mechanical impact, apply additional protective measures such as cages or guards.

These specifications ensure safe and reliable operation of the Duplex AGSS Control Panel, while meeting the applicable design and safety requirements under EU MDR Annex I, Chapter II.

Mounting



Consideration should be given to the mounting of the Control Panel, in proximity to the Plant/Pumps under control and clear of walkways and access to other equipment. The Control Panel should be mounted using ALL 4no corner fixing points provided, by means of the four mounting holes on the site structure.

Always ensure a free flow of air to the connected Pumps/Plant. If the plant is mounted in an enclosure, allow sufficient air space within the enclosure to avoid nuisance thermal tripping. Follow the Pump/Plant Manufacturers literature for guidance.

Electrical Connections



The prospective fault current must not exceed 1.5kA. The earth fault loop impedance of the supply at the plant terminals must not exceed 1 ohm.

Check with the Pump/Plant Manufacturers literature for Voltage and Current Ratings required for the supply

Note: The Control Panel will draw under 100ma from a single phase of the overall supply.

Three phase plant.

Note. This plant requires a neutral. See Drawing DUPLEX8

Single phase plant.

See Drawing DUPLEX10

All Plant.

Replace fuses only with motor rated fuses, rated at the motor full load current.
Do not use this plant with any control, indication or interface system other than that supplied by the manufacturers.

A relay interface is available giving volt-free contacts rated at 5 amps, 240 volts resistive, for Power on, System on, Duty Failed and System Failed signals, and providing input terminals for control from volt-free contacts.

When using remote control units or relay interfaces, connect the terminals on the lower edge of the printed circuit board in the control panel marked RUN, SF, SIU, -Ve, +Ve & CTL to the corresponding terminals on the remote-control units or relay interfaces.

A maximum of 6 remote control units may be used with a control panel. The voltage drop on the cable to the remote-control units should not exceed 1.2 volts (the current drawn is .017 amps per remote control unit + .03 amps. 6 remote control units could be used on 300 M of 1.5mm cable) Cable exceeding 2.5mm should not be used.

It is recommended that Thermal Trip leads are fitted. These leads provide a resistive input across the TS1 and TS2 terminals on the Control PCB. As the chassis temperature on the Plant/Pump increases the resistance lowers until it reaches 80ohms (approx. 85 degree C) which will activate the Thermal Trip warning for the respective pump.



If thermal trip leads are not in used, it is essential the Pumps/Plants in use incorporate their own thermal protection.



When using a relay interface, connect the terminals marked "Local" on the relay interface to the contacts which will control the plant e.g. theatre panel switch. These contacts must be volt-free.



Use the contacts on the relay interface to switch other circuits as required.
When using the relay interface to switch indicator lamps on theatre panels etc. we strongly recommend that System On, Duty Failed and System Failed conditions are displayed as a minimum, and that lamps are used which are of equal brightness and reliability to the lamps used on the standard remote-control unit,



When not using remote control units or relay interfaces, link the terminals on the main control PCB marked +Ve & CTL. This pulls the CTRL input high and calls the Duty Pump permanently.

Mechanical

Connect the suction & discharge hoses to the plant and pipelines as shown on drawing DUPLEX12.

Setting Up

Check the rotation of the motors on three phase plant is correct. If the rotation is incorrect, isolate the supply and reverse two phases.

With all remote-control units switched off, check that the pumps are not running and that all remote-control units and the control panel show a Power On lamp only.

Switch on each remote-control unit in turn. As the pump switches on, the System Failed lamp will come on momentarily as the pump produces vacuum in the pipeline, followed by the System On lamp. Switch off this remote-control unit & continue to the next. If the System Failure lamp does not operate correctly, reset the pressure switch as follows:

- Disconnect the suction hoses from the plant.
- Switch on the plant.
 - If the System Failure lamp is on, turn the pressure switch adjusting screw (see drawing DUPLEX4) clockwise until the System Failure lamp goes out. Turn the adjusting screw anti-clockwise until the System Failure lamp comes on and continue for 3/4 turn (If the system is operated at a very low vacuum, it may be necessary to use a lower setting).
- Replace the suction hose and pressure switch cover.
- Disconnect the suction pipework assembly from the pipeline.
- Switch on a remote-control unit.
 - The duty pump should start with the System Failed lamp showing.
- Wait until the stand-by pump starts.
- Reconnect the suction pipework assembly.
- Go to each remote-control unit in turn.
 - Switch on and check that the Duty Failed lamp is on.
- Reset the control panel with the reset button and check that the stand-by pump stops.

Set up the system flow as described in current standards, using the balance valve to set the operation vacuum in the pipeline.



Operator

Typically, the operator should be at one of the 6no Remote Control Switches. Technical servicing and monitoring would be at the Control Panel at the main plant.

Each Remote-Control Switch Unit includes:

- Four long-life, block LEDs which show the conditions of the service through a wipe-clean membrane. The inherent design includes Red/Yellow/Green LED variations as per industry HTM guidelines and the use of colour recognition ensures that the unit can be monitored comfortably from a distance of 3-4 metres.
- A On/Off rocker switch. This comprises two poles.
 - One pole to 'call' the pump and switches on the vacuum, by bring the CTRL to +Ve.
 - One pole to enable the Duty Run, Standby In Use or System Fault LEDs.
 - (the Power ON LED will be ON whenever the Plant Isolator is ON)

The Central Plant Control Panel Includes:

- Power Supply Isolator (the Panel cannot be Opened when the Isolator is Switched ON).
- Four long-life, block LEDs which show the conditions of the service through a wipe-clean membrane. The inherent design includes Red/Yellow/Green LED variations as per industry HTM guidelines and the use of colour recognition ensures that the unit can be monitored comfortably from a distance of 3-4 metres.
- Reset push-button. This is a momentary action single pole switch which can be used to clear any Status Fault (i.e. Duty Failed (Standby In Use) or Thermal Trip warnings).
- Duty push-button. The is also a momentary action single pole switch which swaps the Duty designation of the pumps from either.
 - Pump 1 (top) to Pump 2 (bottom) or
 - Pump 2 (bottom) to Pump 1 (top)
- Duty Selected LEDs. There are two 5mm round green LEDs to indicate which Pump is currently designated as Duty (one should be ON, and one should be OFF at all times when Isolator is ON).
- Pump Running LEDs. Again, there are two 5mm green round LEDs. Here, they indicate which Pump is currently running to achieve vacuum (one should be ON, and one should be OFF at all times when Isolator is ON).
- Thermal Trip LEDs. Two 5mm red round LEDs. Where the pump chassis has reached 85deg C (or higher) this LED for the overheated pump will switch on and that same pump will switch off (if Duty pump thermally trips the standby pump will start, if standby thermally trips both pumps will be off, to protect against fire risk).

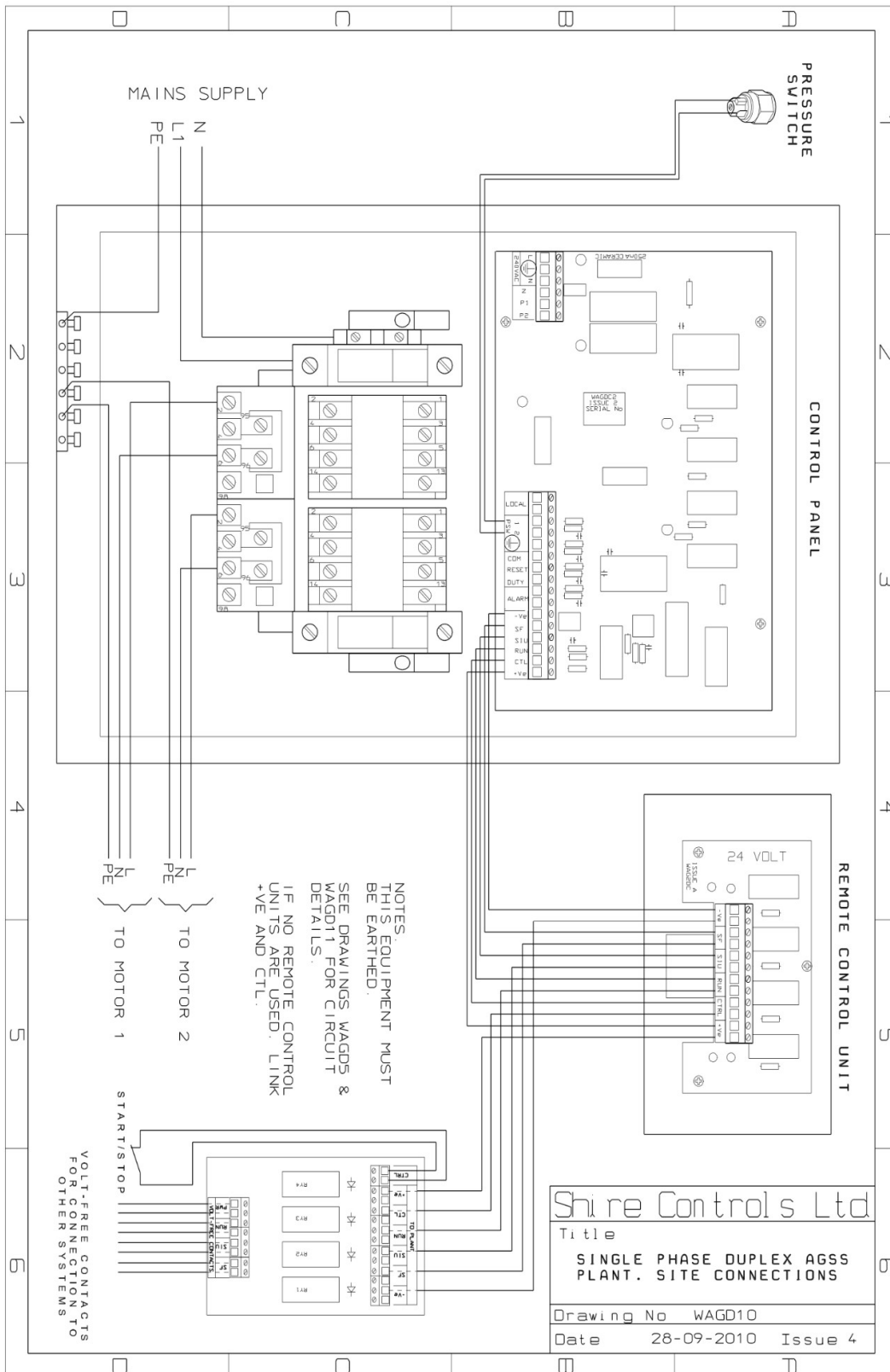

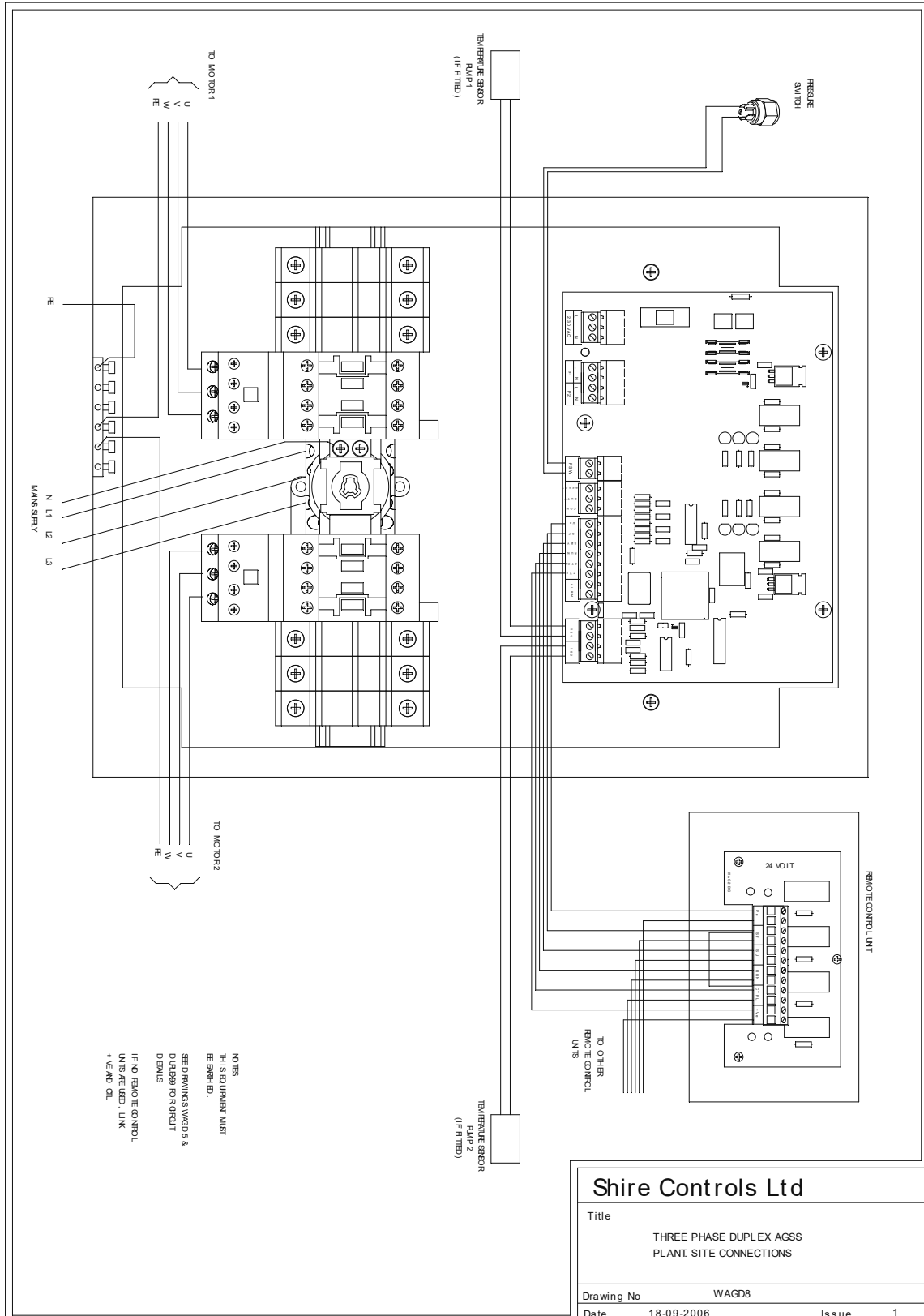

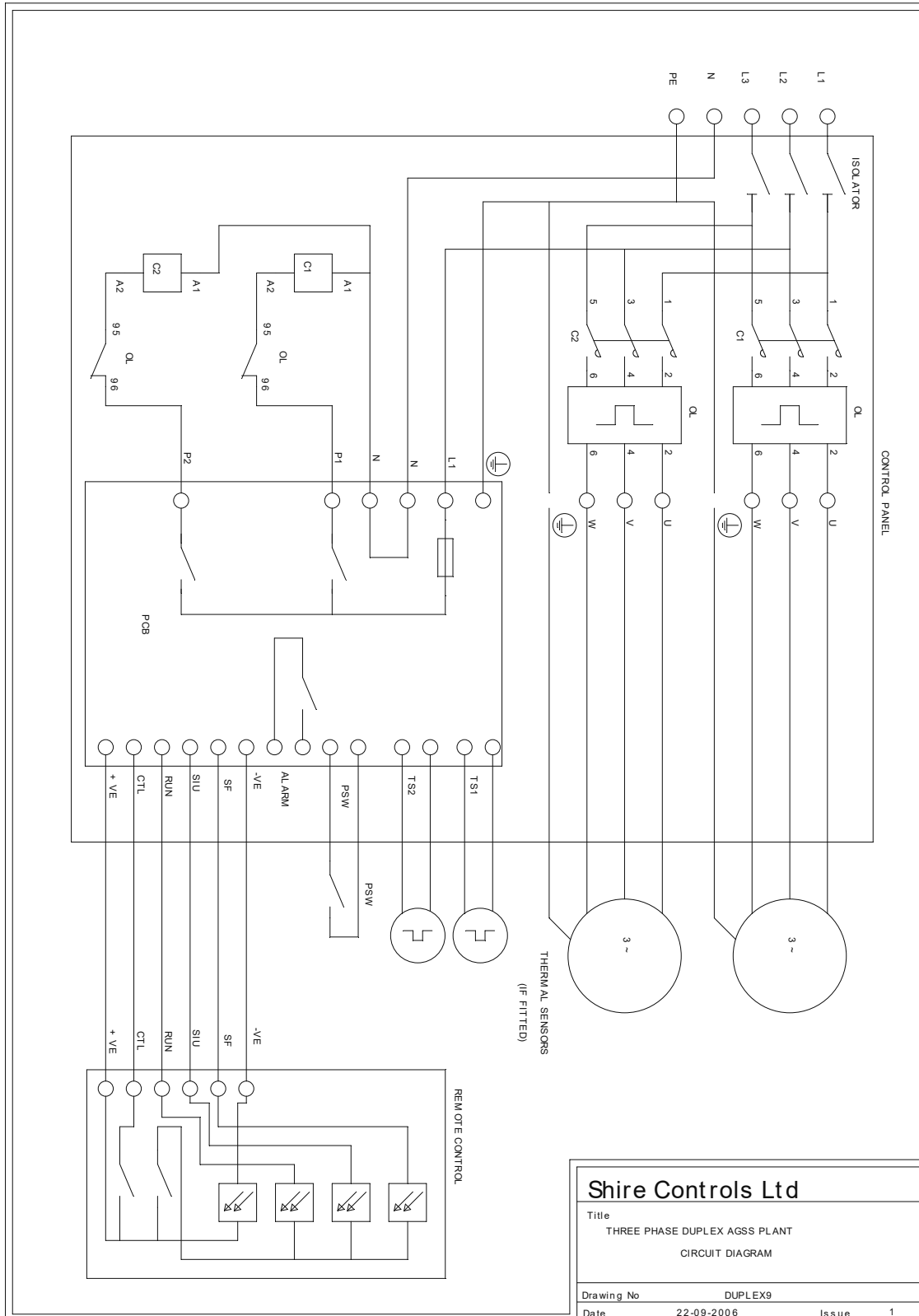

Shire Controls Ltd

Title
THREE PHASE DUPLEX AGSS PLANT
CIRCUIT DIAGRAM

Drawing No DUPLEX9

Date 22-09-2006

Issue 1

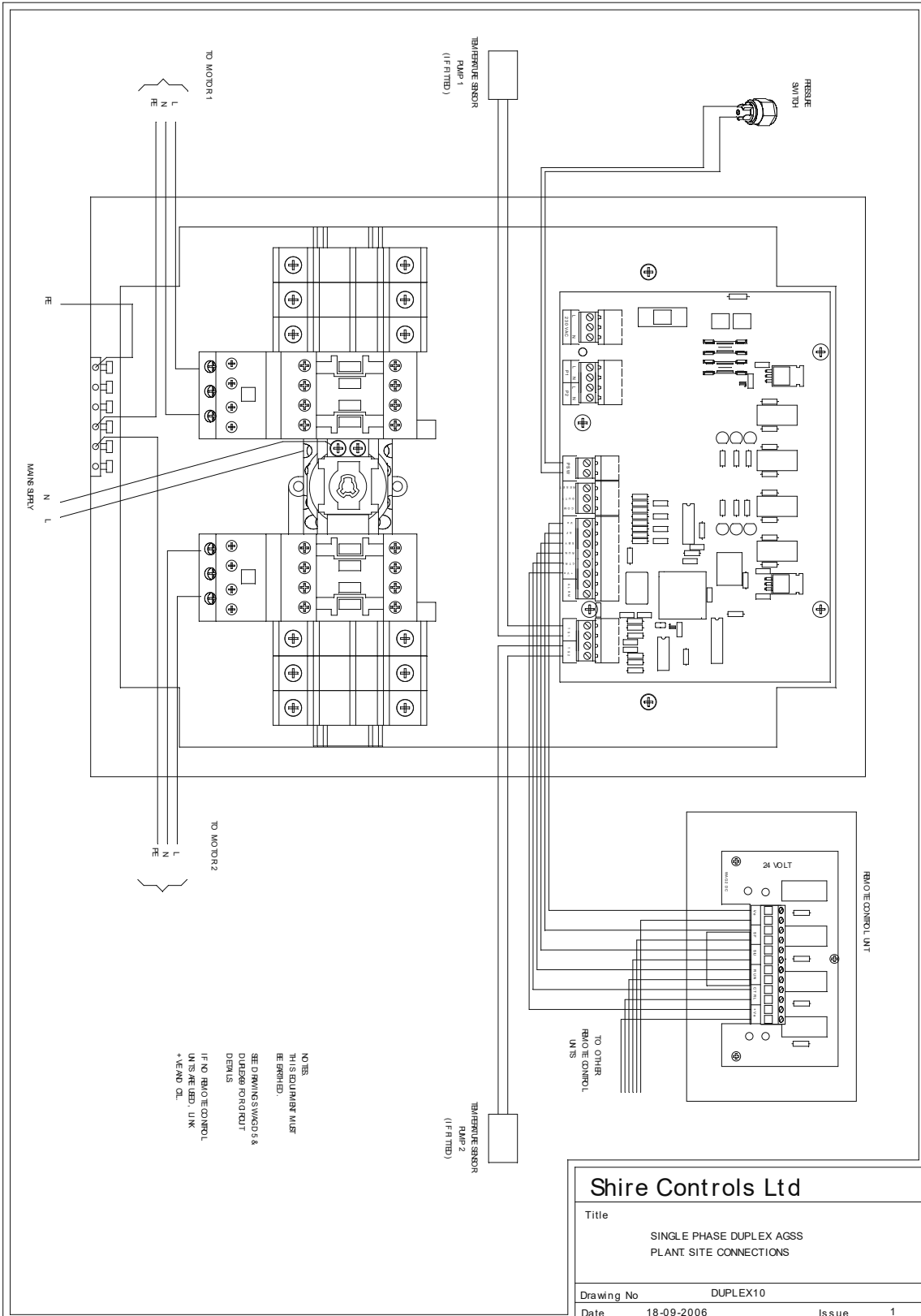

Shire Controls Ltd

Title
SINGLE PHASE DUPLEX AGSS
PLANT SITE CONNECTIONS

Drawing No DUPLEX10

Date 18-09-2006

Issue 1

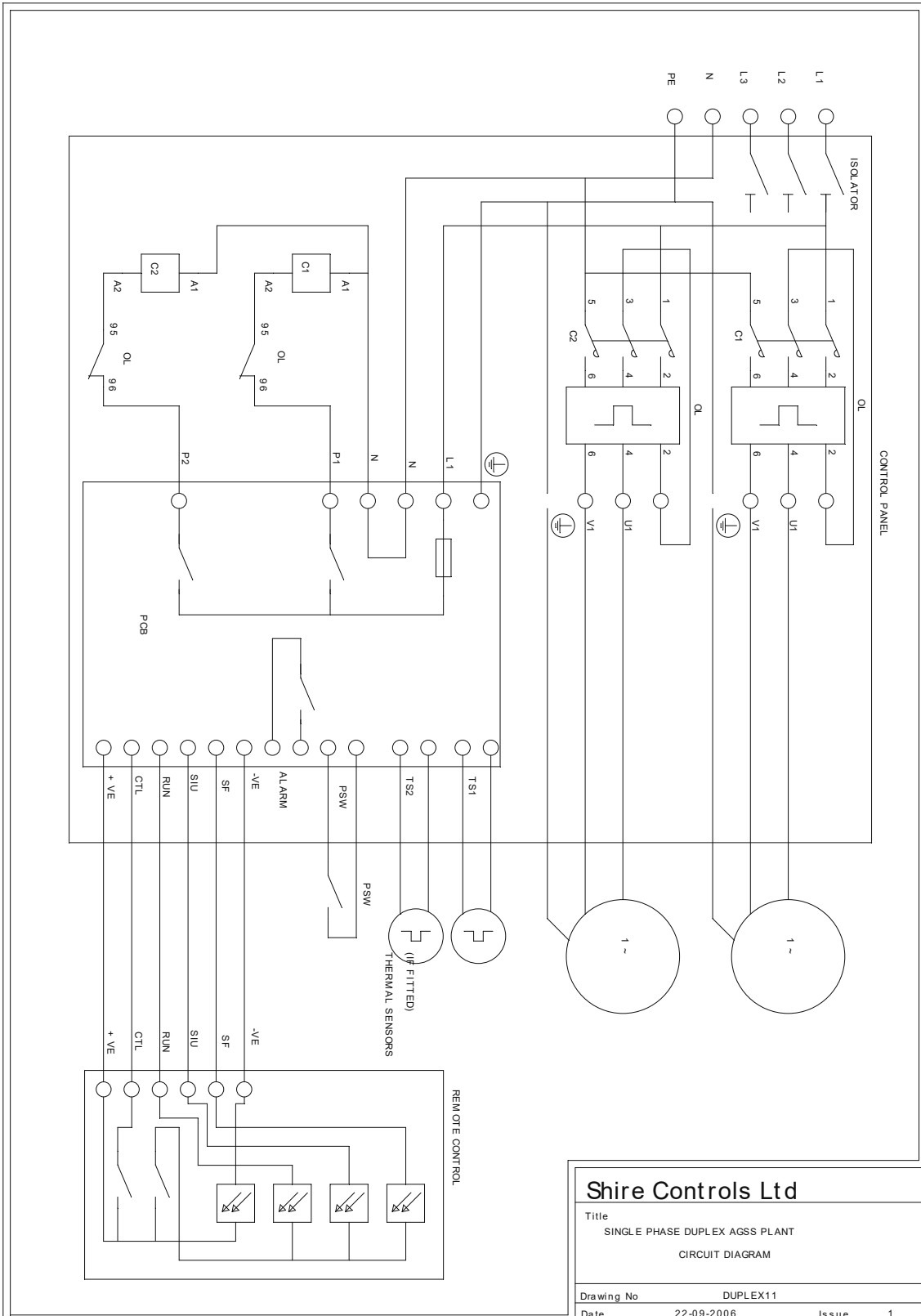

Shire Controls Ltd

Title
SINGLE PHASE DUPLEX AGSS PLANT
CIRCUIT DIAGRAM

Drawing No DUPLEX11

Date 22-09-2006 Issue 1



IMPORTANT. Ensure that an air flow is maintained through the pump via the balance valve when all terminal outlets are closed. Failure to allow an air flow will result in overheating of the pump with possible damage to the pump, motor and hoses and possible injury to personnel.

Check Pump manufacturers literature to ensure that minimum flow rates are observed.

Operation

Once the power supply is connected to the Control Panel and the Isolator Switch is turned ON, switching, on any Remote-Control Switch Unit will start the plant. Indication of System On, Duty Failed (standby in use) or System Failure will be given at any Remote-Control Unit which is switched on (in addition to the plant control panel itself).

The plant will continue to run until ALL remote-control units are switched off.

The Isolator switch (off) on the control panel will prevent the plant being started from a remote-control unit if it is switched off.

The Isolator switch (on) will not start the plant when switched on but will enable control from Remote Control Switches.

When the Control Panel Isolator is On and ANY Remote-Control Unit Switch is ON, the Duty Pump will start. The System Failure lamp will show momentarily as the pump produces a vacuum in the pipeline. This will change to System On as vacuum is produced.

If the duty pump fails to produce vacuum e.g. if the overload or the thermal protection has tripped, the duty pump will stop and once vacuum has been lost for a preset period (see PCB switch operations) the stand-by pump will start. If the stand-by pump produces vacuum in the pipeline, the Standby In Use lamp will show, indicating that the AGSS system is functioning but needs attention. If the stand-by pump also fails to produce vacuum, the System Failed lamp will show.

To return to normal operation after rectifying the fault on the duty pump, operate the Reset button on the control panel. The stand-by pump will stop, and the duty pump will start.

To change over duty pump, operate the Duty push button on the control panel. It is not possible to change duty onto a pump which has failed and caused the stand-by pump to operate until the system is Reset (see above).

To protect the pump mechanism the system incorporates a 2-core cable with a M8 crimp ring end.

An alarm output in the form of volt-free contact is closed under normal operating conditions, rated at 50 V dc, 50mA. This contact will open if the power fails or the duty pump trips.

PCB Switch Functions

Two switches are now incorporated within the PCB design. Switch 1 (a 6-way DIL switch) and Switch 2 (a momentary action push button switch) enable additional operational functions, as follows:

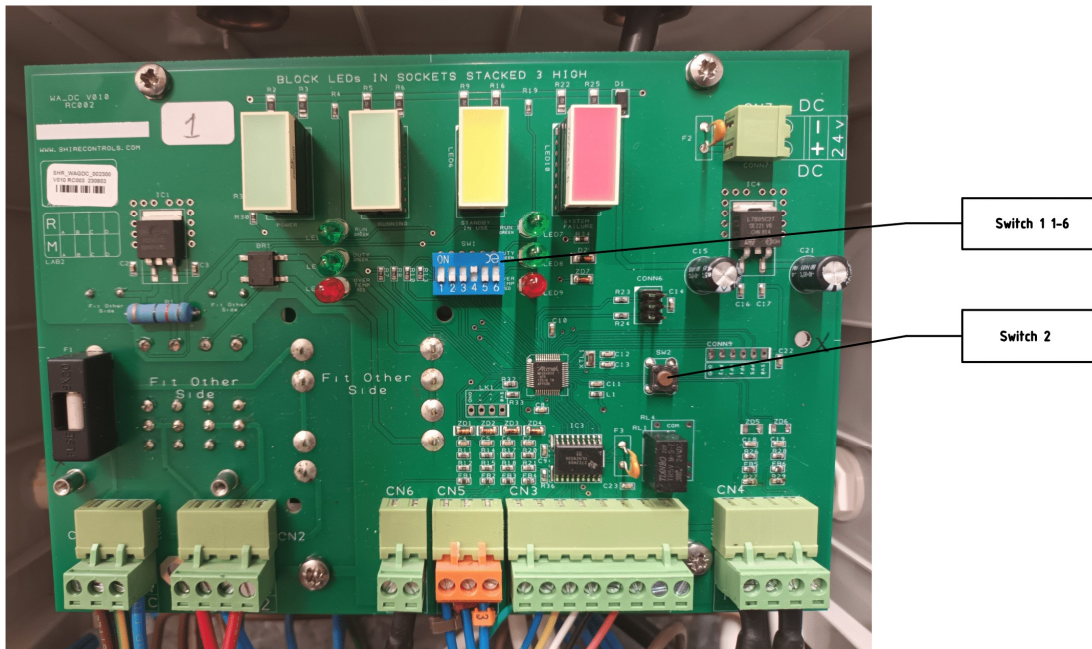



Switch

DIL 1 and 2 allow the manual disabling of either pump 1 or pump 2 due to mechanical failure or precaution. Where a pump has been disabled in this way, the control panel will run the opposite run as if the disabled pump has failed to pull a vacuum for the predetermined period.

The Duty will remain designated to the disabled pump and the Pump Run will set to the opposite pump. System status will then run between Standby In Use and System fault (depending on vacuum produced). This acts as a visual warning that the system only has one pump available.

Also, Thermal Trip warning light will flash to show that a pump has been manually disabled.

NOTE: Do not inhibit both pumps simultaneously. In this instance the plant should be isolated.

Switch	On	Off
SW1.1	Pump 1 Disable	Pump 1 Enable
SW1.2	Pump 2 Disable	Pump 2 Enable

DIL 3 & 4 are used to enabled 1 of 3 preset times (or disabled) for the designated Duty Pump to automatically change to the opposite pump. For the 15-, 30- & 60-hours settings, the Duty Pump will swap over after the designated period only after the pump has been manually switched off and then switched back, on at a later time.

NOTE: It was determined that the swap over should not happen whilst a pump is running effectively and that the actual swap should only happen when the pumps are NOT in operation.

SW1.3	SW1.4	Auto Duty Function
Off	Off	Disabled
Off	On	Duty swap after 15 hours running
On	Off	Duty swap after 30 hours running
On	On	Duty swap after 60 hours running



DIL 5 & 6 are used to set the time delay allowed for loss of vacuum. The table below shows the delay options available (3 seconds typically use for in-house testing).

If a Duty pump fails to draw vacuum for the period determined by these switch settings, then the Duty pump will stop and the Standby pump will switch on (as described above).

SW1.5	SW1.6	Pressure faults hold off
Off	Off	3 Seconds
Off	On	10 Seconds
On	Off	20 Seconds
On	On	30 Seconds

Testing (Switch 2)

This switch is a momentary action (push to break, release to make) switch. This switch provides a straightforward way of demonstrating the changeover function of the pump without having to dis-connect.

Pushing the button simulates a loss of vacuum (whilst held in). If the button is held in for longer than the pre-determined time (set by Switch 1 DIL 5 & 6 above) then the Duty pump will change to standby pump.



Maintenance

The filter on the balance valve must be cleaned or replaced periodically. The frequency of these inspections will depend on operating environment & should be determined by experience.















Every 6 months.

- Isolate the plant & remove the motor fuses to prevent the pumps starting.
- Switch the power back on.
- Go to each remote-control unit or other point at which the plant conditions are displayed in turn.
- Turn the plant on & check that the System Failed lamp comes on (remember to allow enough time for the duty pump to trip when checking the first remote control).
- Turn off the plant & repeat for all other control positions.
- Next isolate the pump and replace the motor fuses for Pump 1 only.
- Switch on the power.
- Start the plant and wait for it to trip.
- Go to each remote-control unit in turn. Switch on & check that Duty Failed lamp is on. Reset the plant.
- Isolate and replace the fuses for pump 2.









Every 2 Years

- Isolate the plant & remove the motor fuses to prevent the pumps starting.
- Dis-assemble and clean Non-Return Valves
- Dis-assemble and clean Balance Valves.
- Clean or replace the Balance Valve filter.
- Replace Thermal Trip Leads (is used).

Symbols

Symbol	Explanation
	Medical Device
	Do not use if package is damaged and consult the instructions for use
	Humidity Limitation
	Keep Away from Sunlight
	Non-Sterile
	Keep Dry
	Caution
	Fragile
	Storage Temperature
	Manufacturer
	Date of Manufacture
	Serial Number
	Observe the Instructions for use
	UKCA Marking
	CE Marking European Union directives & regulations (including (EU) 2017/745 MDR)

UDI-DI & UDI-DI Label

 <p>Duplex AGSS Anaesthetic Gas Scavenging System</p>	<p>AGS130 duplex plant</p> <p># Model No. agss1303d</p>	    
<p>QTY: 1</p> <p>SN 1234</p> <p>UDI</p> 	<p>NON STERILE</p> <p>EC REP</p>	 <p>Shire Controls Ltd Studio 3 Channoaks Farm, Gilston, Harlow, Essex CM20 2RL, UK shiremedical.co.uk</p> <p>OMC NI Medical Unit 763, Moat House Business Centre, Belfast BT5 5AD, UK (Northern Ireland only)</p> <p>2026-04-15</p> 
<p>(01) 5061122261234</p> <p>(11) 2026-04-15</p> <p>(21) 1234</p>		



INSTRUCTIONS FOR USE
Shire Controls Ltd.
Duplex AGSS Control Panel

Spares Parts List

Description	Part Number	Supplier
Control Panel Box	GW42010 or SH885	Gewiss or Shire Controls Ltd
Control PCB WAGDC V010_RC004	agssduplexpcbcomplete	Shire Controls Ltd
Contactora	3RT10 17-1AP01 or SH357	Siemens or Shire Controls Ltd
Overload (See Pump Tables)	3RU1116-1**0 & SH**	Siemens or Shire Controls Ltd
Alternatives: -		
Contactora	5.5Kw	IMO, Lovato
Overload	To Match Contactora	IMO, Lovato
Fuse (See Pump Tables)	C10M* or SH**	Bussman or Shire Controls Ltd
Fuse Holder	CHM3D (3 Ph) or CHM1D (1 Ph) SH577 (3 Ph) or SH576 (1 Ph)	Bussman or Shire Controls Ltd
Pushbutton	MP0031 or SH628	Bulgin or Shire Controls Ltd
Fuse F1 250mA ceramic	S501 250mA	Bussman
Fuse F2 & F3 2A	S500 2A	Bussman
Duplex Pressure Switch Lead Assembly	agssdpswlead	Shire Controls Ltd
Duplex Thermal Trip Lead Assembly (Pair)	agssdttlead	Shire Controls Ltd
Remote control (Flush)	wag2240f	Shire Controls Ltd
Remote control (Surface)	wag2240s	Shire Controls Ltd
AGSS Relay Interface	Wagrid	Shire Controls Ltd



Control Panel Variations

Single Phase Pump Control Panel Part Number	Pump Specification
agssduplex11_16panel1ph	1 Phase Pump With 1.1-1.6 Running Current
agssduplex14_20panel1ph	1 Phase Pump With 1.4-2.0 Running Current
agssduplex22_32panel1ph	1 Phase Pump With 2.2-3.2 Running Current
agssduplex28_40panel1ph	UNI-JET 75 120 230vac 0.4Kw 3.1A
agssduplex35_50panel1ph	1 Phase Pump With 3.5-5.0 Running Current
agssduplex45_63panel1ph	1 Phase Pump With 4.5-6.3 Running Current
agssduplex55_80panel1ph	TECNO JET 130 230vac 0.75Kw 6A
agssduplex70_100panel1ph	FLUX JET 141 230vac 1.1Kw 7.6A
agssduplex90_120panel1ph	FLUX JET 141 230vac 1.5Kw 10.0A
Three Phase Pump Control Panel Part Number	Pump Specification
agssduplex11_16panel3ph	UNI-JET T2 75 120 415vac 50hz 0.4kw 1.4A
agssduplex14_20panel3ph	3 Phase Pump With 1.4-2.0 Running Current
agssduplex28_40panel3ph	TECNO JET T2 130 415vac 50hz 1.1kw 3A
agssduplex22_32panel3ph	TECNO JET T2 130 415vac 50Hz 0.75kw 2.7A
agssduplex35_50panel3ph	FLUX JET 142 415vac 50hz 1.5kw 4a Pump
agssduplex45_63panel3ph	MEDIO JET 152 415vac 2.2Kw 5.2A
Agssduplex90_120panel3ph	3 Phase Pump With 9.0-12.0 Running Current

History

- 1.1 Issued For ISO13485
- 1.2 Updated to Include information on validated information
(Environment, Symbols, Labelling, & Structural)
- 1.3 Updating of Parts Lists
- 1.4 Updated to include EU MDR Label